

CONTO CONSUNTIVO 2011



Comune di Borgofranco d'Ivrea

11 aprile 2012

*Relazione al Consiglio Comunale
Ass. al Bilancio Francesconi*

Accertamenti 2011

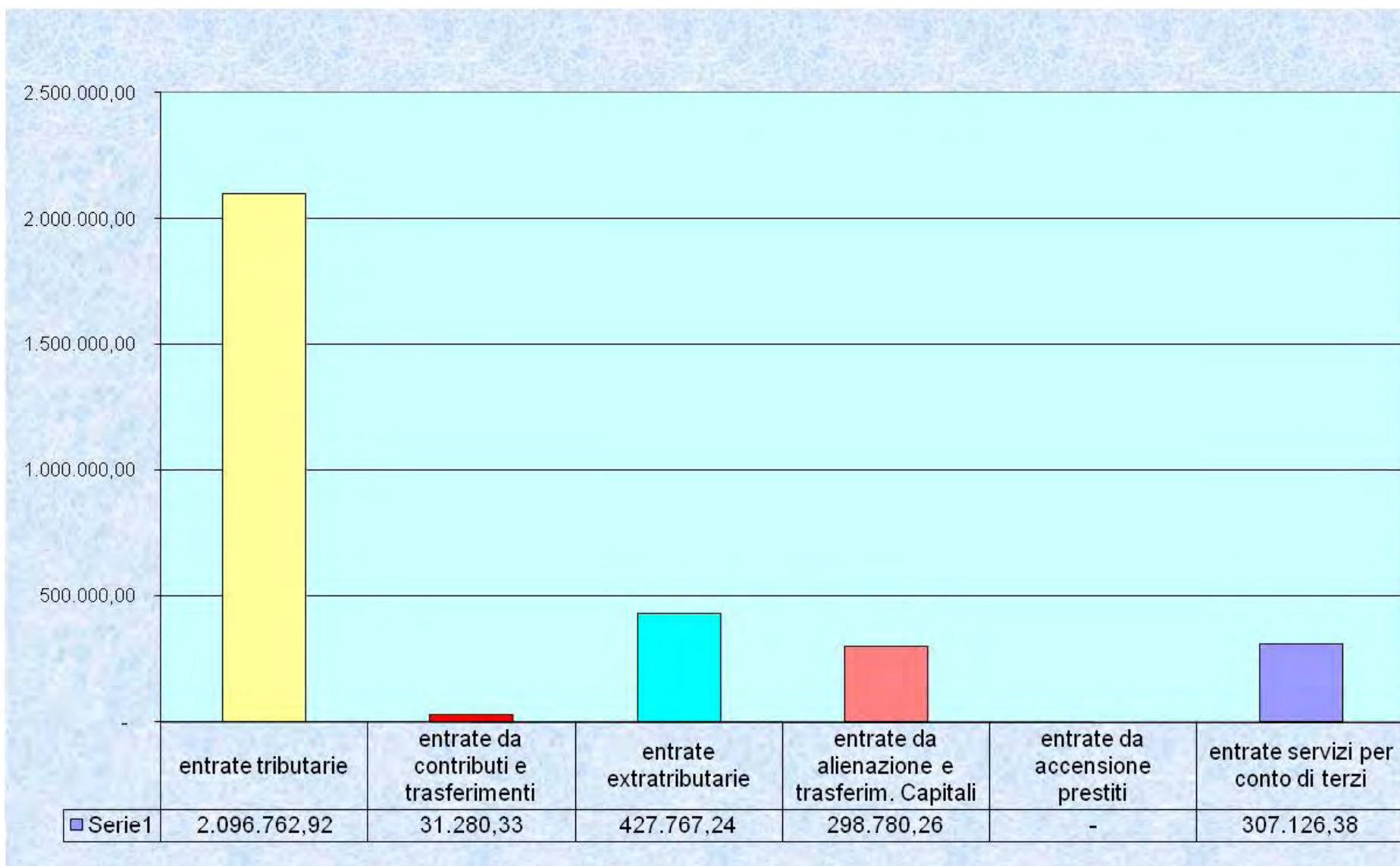

Entrate tributarie

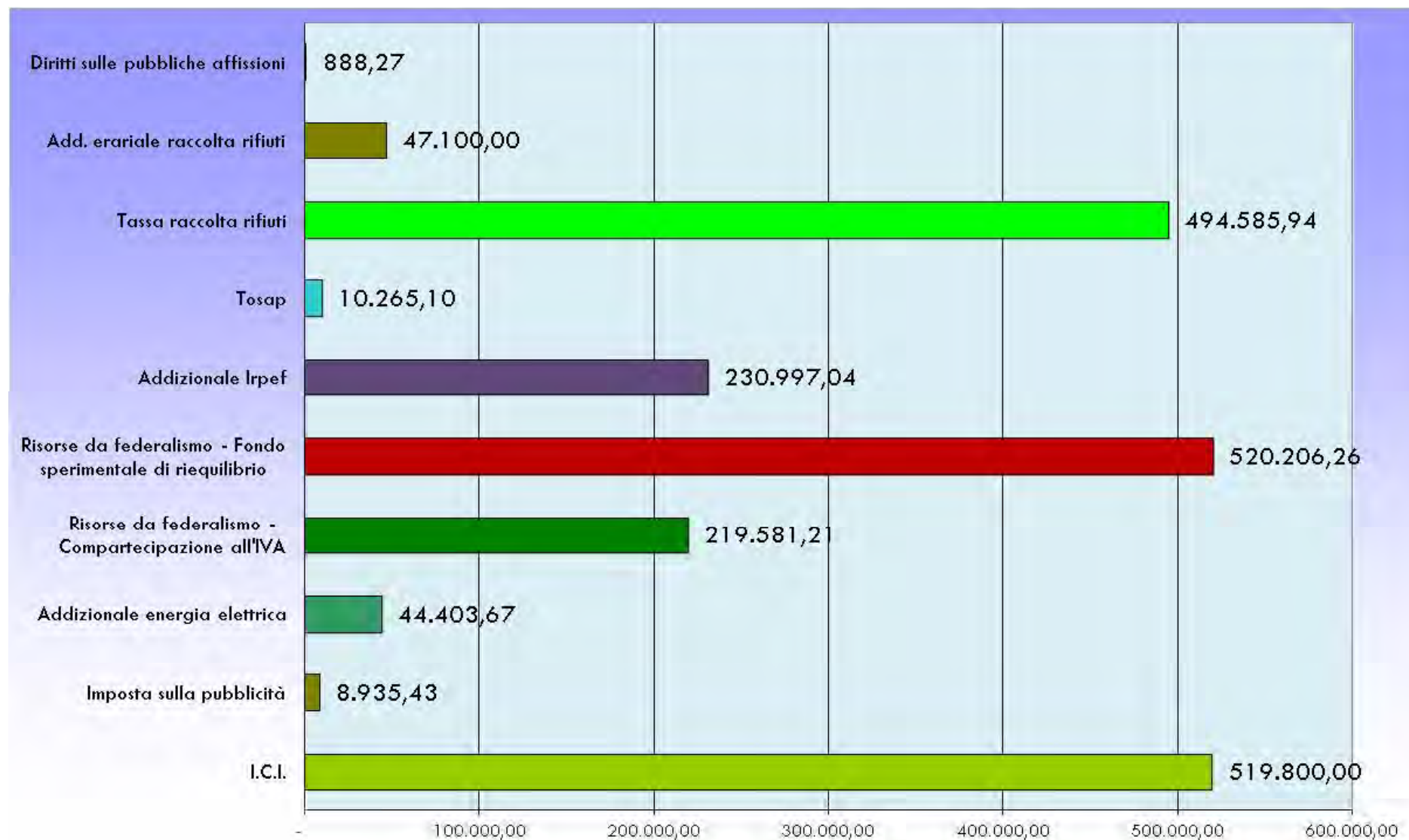

Impegni 2011

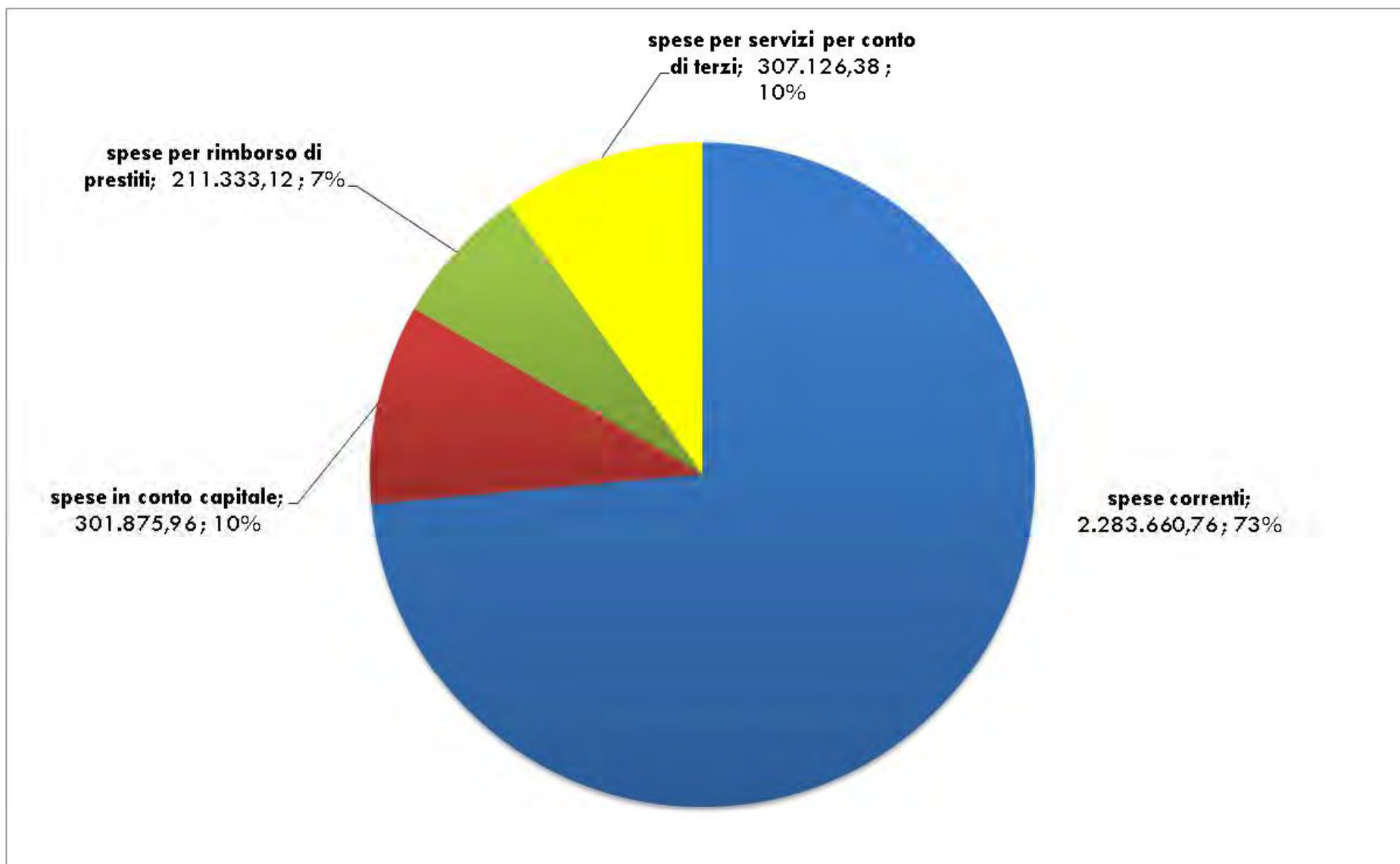

Impegni correnti in base alle categorie economiche

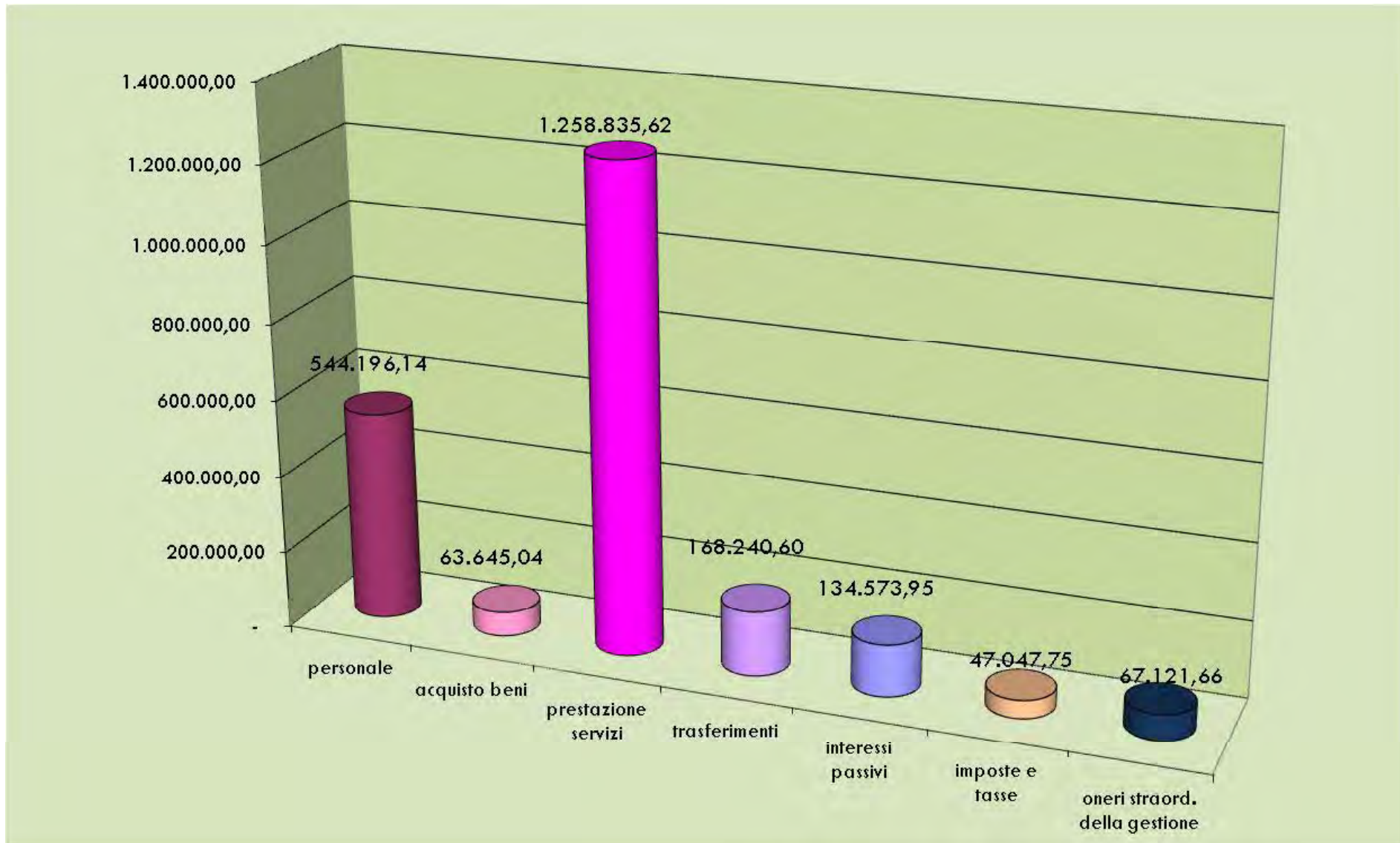

Impegni in base alle funzioni

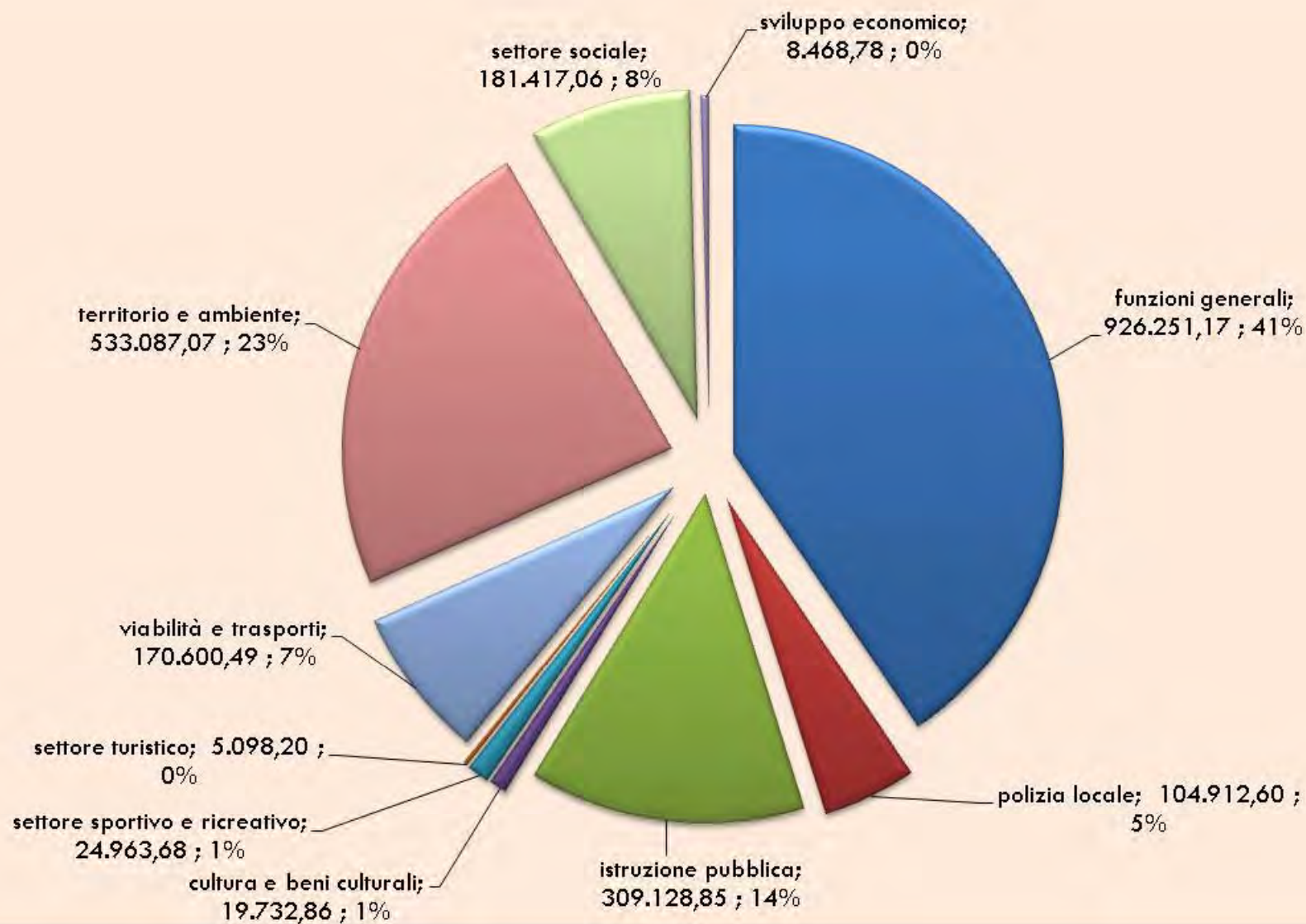

Rapporto fra avanzo di amministrazione e impegni

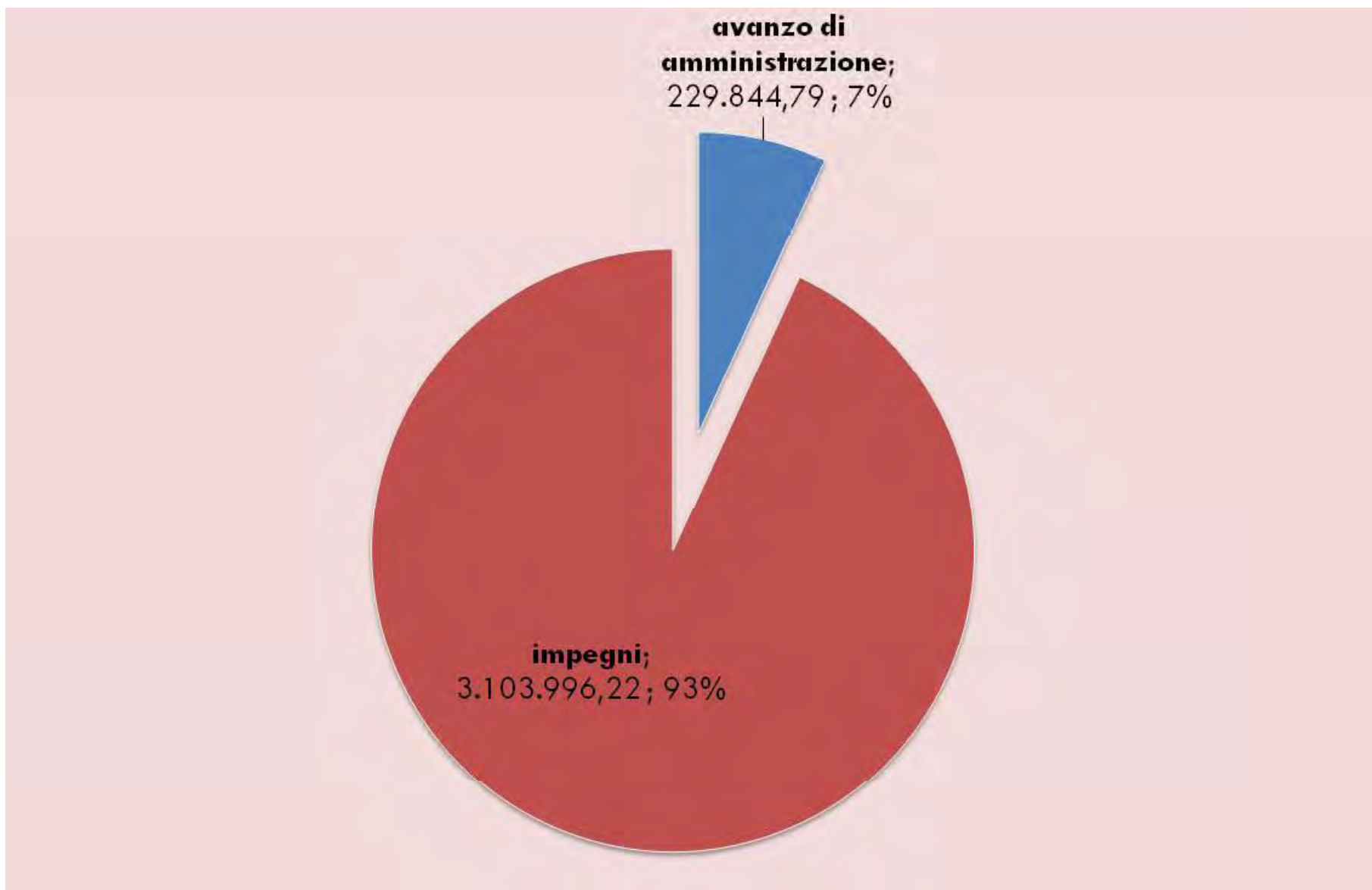

Ripartizione Spese (titoli I e III) in base ai programmi

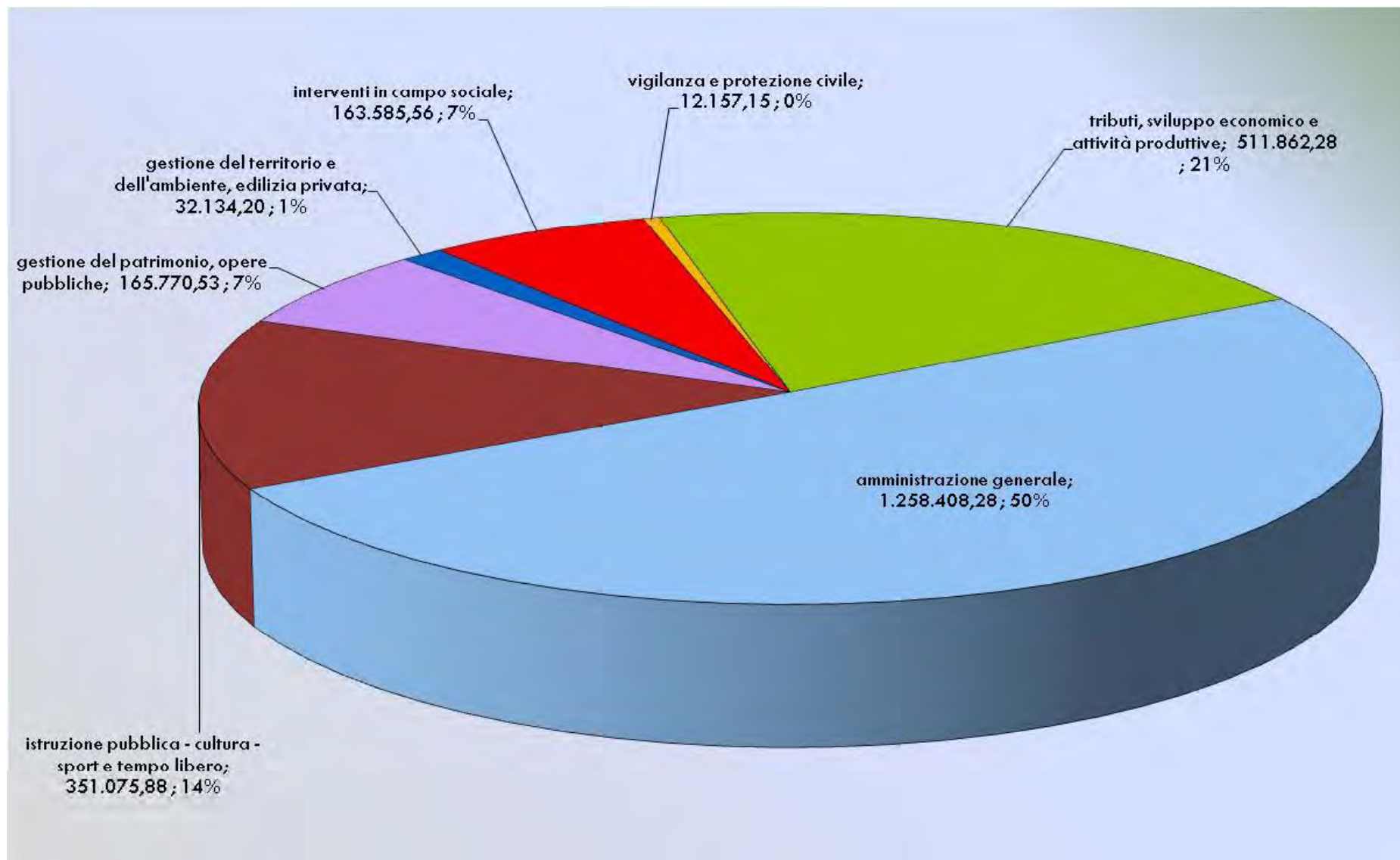

Spese di investimento in base ai finanziamenti

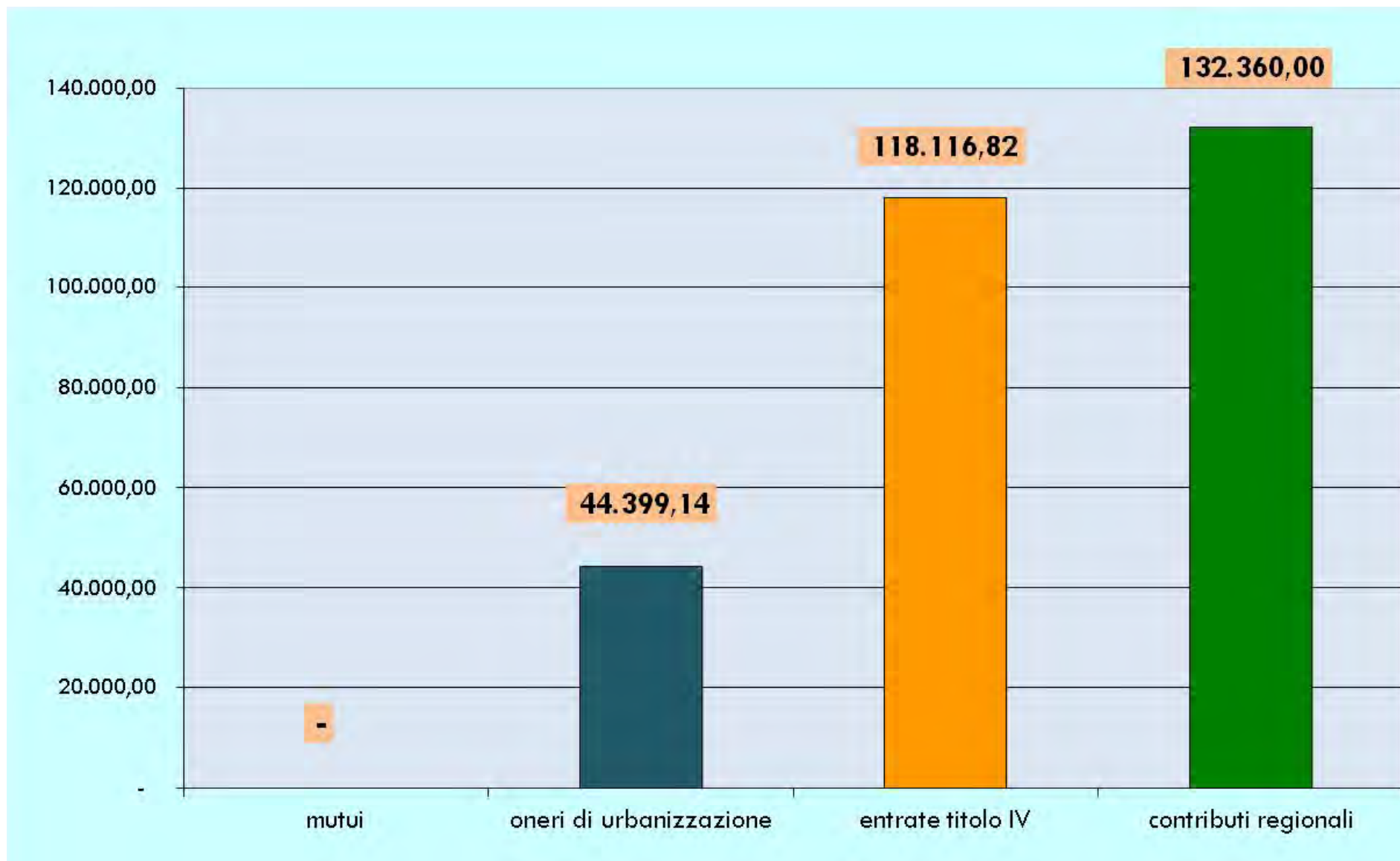

Confronto fra entrate correnti e oneri per mutui (quota interessi e capitale)

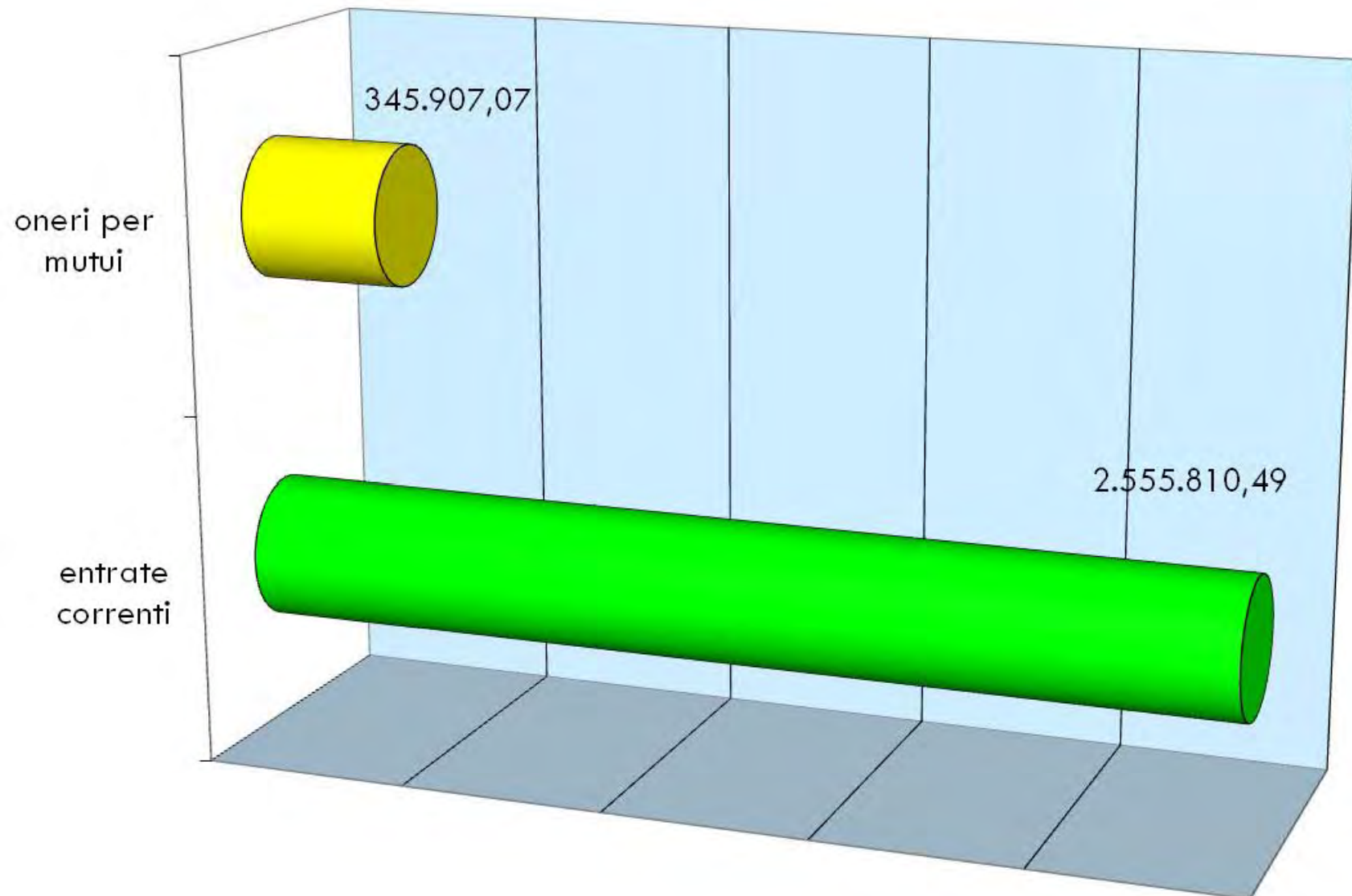

Entrate 2011 - confronto fra previsioni definitive e accertamenti

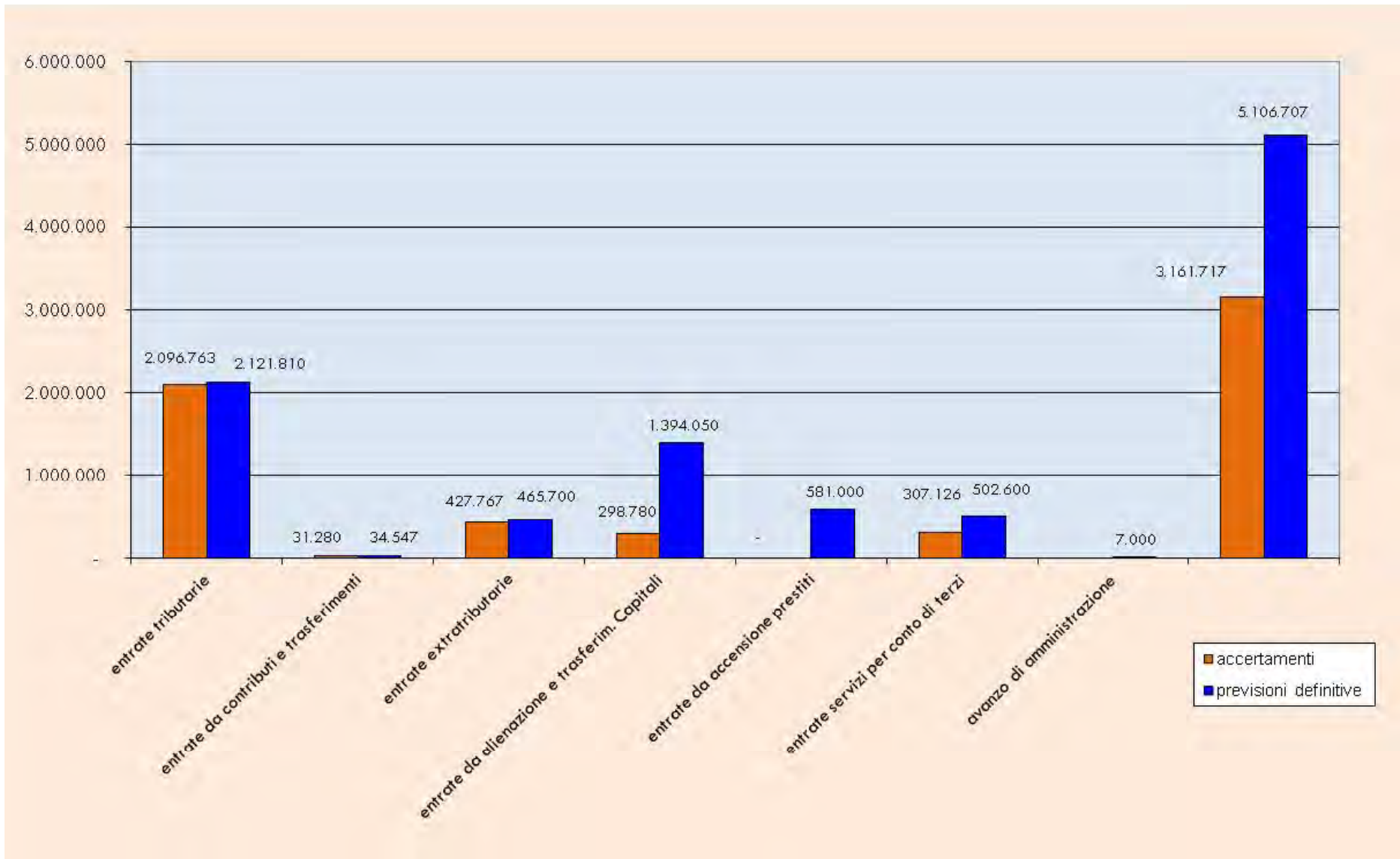

Spese 2011 - confronto fra previsioni definitive e impegni

